

Triple XXX™ 112/212 Combo Operation Manual



For more information on other great Peavey products, go to your local Peavey dealer or online at www.peavey.com.





Intended to alert the user to the presence of uninsulated “dangerous voltage” within the product’s enclosure that may be of sufficient magnitude to constitute a risk of electric shock to persons.



Intended to alert the user of the presence of important operating and maintenance (servicing) instructions in the literature accompanying the product.

CAUTION: Risk of electrical shock — DO NOT OPEN!

CAUTION: To reduce the risk of electric shock, do not remove cover. No user serviceable parts inside. Refer servicing to qualified service personnel.

WARNING: To prevent electrical shock or fire hazard, do not expose this appliance to rain or moisture. Before using this appliance, read the operating guide for further warnings.



Este símbolo tiene el propósito, de alertar al usuario de la presencia de “(voltaje) peligroso” sin aislamiento dentro de la caja del producto y que puede tener una magnitud suficiente como para constituir riesgo de descarga eléctrica.



Este símbolo tiene el propósito de alertar al usuario de la presencia de instrucciones importantes sobre la operación y mantenimiento en la información que viene con el producto.

PRECAUCION: Riesgo de descarga eléctrica ¡NO ABRIR!

PRECAUCION: Para disminuir el riesgo de descarga eléctrica, no abra la cubierta. No hay piezas útiles dentro. Deje todo mantenimiento en manos del personal técnico cualificado.

ADVERTENCIA: Para evitar descargas eléctricas o peligro de incendio, no deje expuesto a la lluvia o humedad este aparato. Antes de usar este aparato, lea más advertencias en la guía de operación.



Ce symbole est utilisé dans ce manuel pour indiquer à l'utilisateur la présence d'une tension dangereuse pouvant être d'amplitude suffisante pour constituer un risque de choc électrique.



Ce symbole est utilisé dans ce manuel pour indiquer à l'utilisateur qu'il ou qu'elle trouvera d'importantes instructions concernant l'utilisation et l'entretien de l'appareil dans le paragraphe signalé.

ATTENTION: Risques de choc électrique — NE PAS OUVRIR!

ATTENTION: Afin de réduire le risque de choc électrique, ne pas enlever le couvercle. Il ne se trouve à l'intérieur aucune pièce pouvant être réparée par l'utilisateur. Confiez l'entretien et la réparation de l'appareil à un réparateur Peavey agréé.

AVERTISSEMENT: Afin de prévenir les risques de décharge électrique ou de feu, n'exposez pas cet appareil à la pluie ou à l'humidité. Avant d'utiliser cet appareil, lisez attentivement les avertissements supplémentaires de ce manuel.



Dieses Symbol soll den Anwender vor unisolierten gefährlichen Spannungen innerhalb des Gehäuses warnen, die von Ausreichender Stärke sind, um einen elektrischen Schlag verursachen zu können.



Dieses Symbol soll den Benutzer auf wichtige Instruktionen in der Bedienungsanleitung aufmerksam machen, die Handhabung und Wartung des Produkts betreffen.

VORSICHT: Risiko — Elektrischer Schlag! Nicht öffnen!

VORSICHT: Um das Risiko eines elektrischen Schlages zu vermeiden, nicht die Abdeckung entfernen. Es befinden sich keine Teile darin, die vom Anwender repariert werden könnten. Reparaturen nur von qualifiziertem Fachpersonal durchführen lassen.

ACHTUNG: Um einen elektrischen Schlag oder Feuergefahr zu vermeiden, sollte dieses Gerät nicht dem Regen oder Feuchtigkeit ausgesetzt werden. Vor Inbetriebnahme unbedingt die Bedienungsanleitung lesen.

IMPORTANT SAFETY INSTRUCTIONS

WARNING: When using electrical products, basic cautions should always be followed, including the following:

1. Read these instructions.
2. Keep these instructions.
3. Heed all warnings.
4. Follow all instructions.
5. Do not use this apparatus near water.
6. Clean only with a dry cloth.
7. Do not block any of the ventilation openings. Install in accordance with manufacturer's instructions.
8. Do not install near any heat sources such as radiators, heat registers, stoves or other apparatus (including amplifiers) that produce heat.
9. Do not defeat the safety purpose of the polarized or grounding-type plug. A polarized plug has two blades with one wider than the other. A grounding type plug has two blades and a third grounding prong. The wide blade or third prong is provided for your safety. If the provided plug does not fit into your outlet, consult an electrician for replacement of the obsolete outlet.
10. Protect the power cord from being walked on or pinched, particularly at plugs, convenience receptacles, and the point they exit from the apparatus.
11. Note for UK only: If the colors of the wires in the mains lead of this unit do not correspond with the terminals in your plug, proceed as follows:
 - a) The wire that is colored green and yellow must be connected to the terminal that is marked by the letter E, the earth symbol, colored green or colored green and yellow.
 - b) The wire that is colored blue must be connected to the terminal that is marked with the letter N or the color black.
 - c) The wire that is colored brown must be connected to the terminal that is marked with the letter L or the color red.
12. Only use attachments/accessories provided by the manufacturer.
13. Use only with a cart, stand, tripod, bracket, or table specified by the manufacturer, or sold with the apparatus. When a cart is used, use caution when moving the cart/apparatus combination to avoid injury from tip-over.
14.  Unplug this apparatus during lightning storms or when unused for long periods of time.
15. Refer all servicing to qualified service personnel. Servicing is required when the apparatus has been damaged in any way, such as power-supply cord or plug is damaged, liquid has been spilled or objects have fallen into the apparatus, the apparatus has been exposed to rain or moisture, does not operate normally, or has been dropped.
16. Never break off the ground pin. Write for our free booklet "Shock Hazard and Grounding." Connect only to a power supply of the type marked on the unit adjacent to the power supply cord.
17. If this product is to be mounted in an equipment rack, rear support should be provided.
18. Exposure to extremely high noise levels may cause a permanent hearing loss. Individuals vary considerably in susceptibility to noise-induced hearing loss, but nearly everyone will lose some hearing if exposed to sufficiently intense noise for a sufficient time. The U.S. Government's Occupational Safety and Health Administration (OSHA) has specified the following permissible noise level exposures:

| Duration Per Day In Hours | Sound Level dBA, Slow Response |
|---------------------------|--------------------------------|
| 8 | 90 |
| 6 | 92 |
| 4 | 95 |
| 3 | 97 |
| 2 | 100 |
| 1 1/2 | 102 |
| 1 | 105 |
| 1/2 | 110 |
| 1/4 or less | 115 |

According to OSHA, any exposure in excess of the above permissible limits could result in some hearing loss. Ear plugs or protectors to the ear canals or over the ears must be worn when operating this amplification system in order to prevent a permanent hearing loss, if exposure is in excess of the limits as set forth above. To ensure against potentially dangerous exposure to high sound pressure levels, it is recommended that all persons exposed to equipment capable of producing high sound pressure levels such as this amplification system be protected by hearing protectors while this unit is in operation.

SAVE THESE INSTRUCTIONS!

ENGLISH



As hot as the name implies, these newest members of the Ultra™ Tube Series rip. From the high-gain input to paralleled speaker output jacks, the Peavey Electronics Triple XXX 212 and 112 Combos are not for the faint of heart. Engineered for today's discriminating guitarist, these amplifiers are loaded with practical features useful in real-world applications. Delivering an earth-quaking 120 Watts of pure tube power, the Triple XXX 212 Combo is easily controllable thanks to a master volume pot, as well as independent volume controls for each of its three channels. The Ultra and Crunch channels also have gain controls to further assist in taming this beast while achieving killer sound. Tone contour is accomplished through passive controls for Bass, Mid, and Treble on the Clean channel, while the Ultra and Crunch channels utilize Peavey's exclusive Bottom, Body, and Edge active controls. Special designed speakers are used to compliment the XXX amplifier. 16 Ohm internal impedance is used so that you can add an external cabinet in parallel by using the 4, 8 and 16 Ohm switch to match the impedance. With footswitchable channel and effects loop, the Triple XXX lets you keep your hands on the guitar - and your eyes on your dream. The Triple XXX 112 Combo shares all these features in a more portable, 60 Watt 112 version.

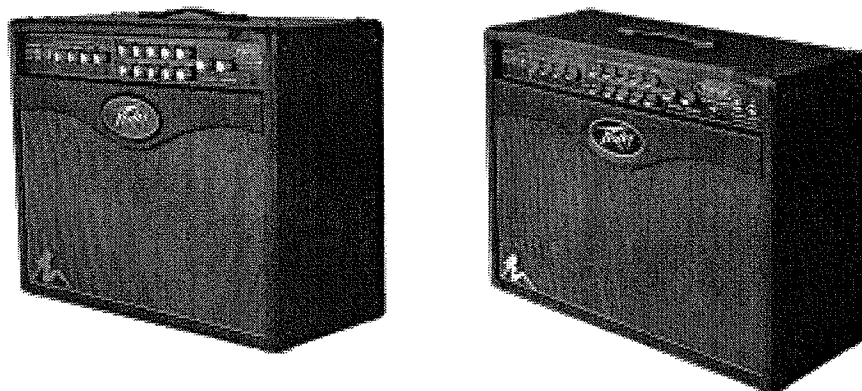

FEATURES

- Three 12AX7 preamp tubes
- Four 6L6GC (two 6L6GC in Triple XXX 112) power amp tubes driven by a 12AX7
- Power amp convertible to use four EL34 tubes (two EL34s) in Triple XXX 112)
- Footswitchable effects loop with independent send and return controls
- Damping switch (Tight, Medium, Loose)
- Special noise gate circuitry on Ultra and Crunch channels
- Line out with level control
- Cabinet impedance switch (4, 8, or 16 Ohms)
- Heavy-duty power, standby and channel select toggle switches
- Classic power status indicator lamp
- Chrome-plated brass control knobs

Front Panel Triple XXX 112

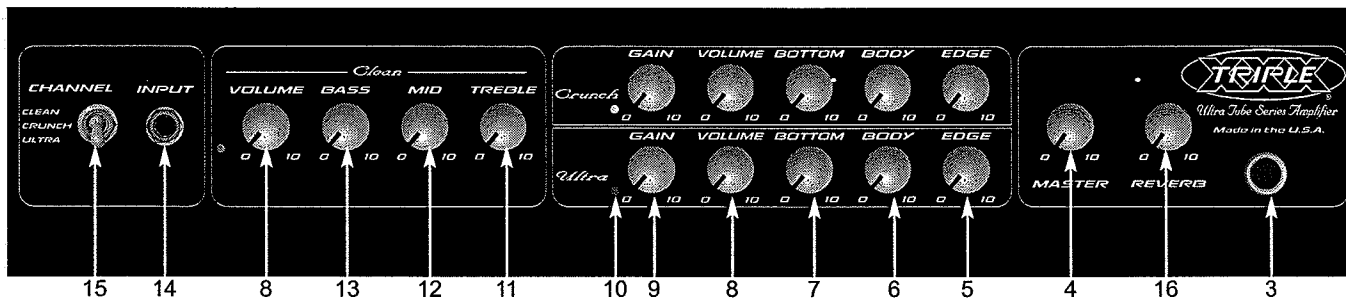

Front Panel Triple XXX 212

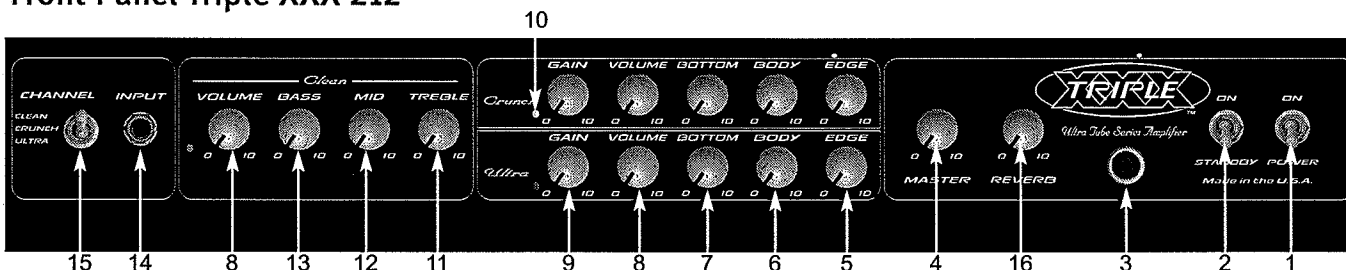

(1) POWER SWITCH

This two-way toggle switch applies mains power to the unit. The red POWER STATUS LAMP (3) will illuminate when this switch is in the ON position.

(2) STANDBY SWITCH

This two-way toggle switch allows the amp to be placed in the STANDBY mode. In the STANDBY position the tubes stay hot but the amplifier is not operational. Switching to the ON position places the amp in active mode.

(3) POWER STATUS LAMP

This indicator illuminates when mains power is being supplied to the amp.

(4) MASTER VOLUME

This control sets the overall volume level of the amp. Once the desired balance between the three channels in the amplifier has been achieved, the entire output level of the unit can be increased or decreased by rotating this control. Clockwise rotation increases level; counterclockwise rotation decreases level.

(5) EDGE

This control, on both the Ultra and Crunch channels, varies the high frequency response of the amplifier. It is an active control (shelving type) and allows 15 dB of boost or cut.

(6) BODY

This control, on both the Ultra and Crunch channels, varies the mid frequency response of the amplifier. It is an active control (peak/notch type) and allows 15 dB of boost or cut.

(7) BOTTOM

This control, on both the Ultra and Crunch channels, varies the low frequency response of the amplifier. It is an active control (shelving type) and allows 15 dB of boost or cut.

- (8) **VOLUME**
This control, on all three channels, sets the overall level of its respective channel.
- (9) **GAIN**
This control, on both the Ultra and Crunch channels, controls the input volume level of the channel. Rotating this control clockwise will increase the amount of preamp distortion and sustain.
- (10) **CHANNEL ACTIVATION LEDs**
These indicators signify which channel is active. Ultra channel activation illuminates the red LED; Crunch channel activation illuminates the yellow LED; and Clean channel activation illuminates the green LED.
- (11) **TREBLE**
This passive control regulates the high frequencies for the Clean channel.
- (12) **MID**
This passive control regulates the mid frequencies for the Clean channel.
- (13) **BASS**
This passive control regulates the low frequencies for the Clean channel.
- (14) **INPUT**
This 1/4" jack is designed to accommodate most any guitar output signal. Input signal gain can be adjusted by the GAIN (9) controls (Ultra and Crunch channels only).
- (15) **CHANNEL SELECT SWITCH**
This three-position toggle switch allows selection between the amplifier's three channels. LED (10) illumination indicates which channel is active. Channel switching can also be accomplished by footswitch. See the FOOTSWITCH section of this manual for explanation of switch operation. The CHANNEL SELECT SWITCH must be set in the Ultra position in order for the footswitch to operate properly.
- (16) **REVERB LEVEL**
Reverberation is an echo effect rotate clockwise to increase the effect.

Rear Panel Triple XXX 112

28

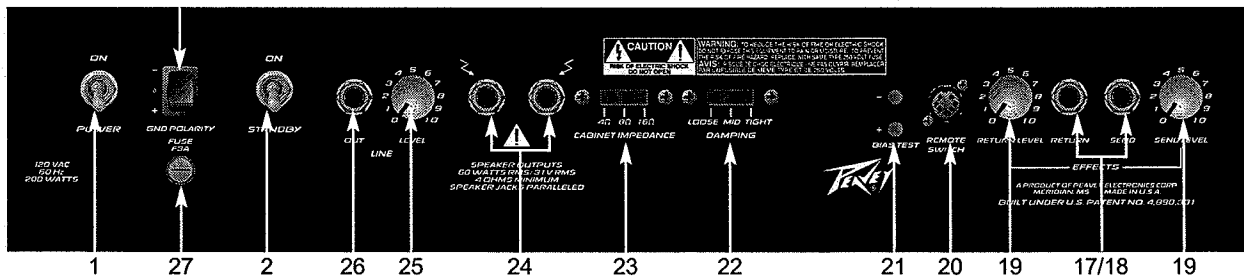

Rear Panel Triple XXX 212

28

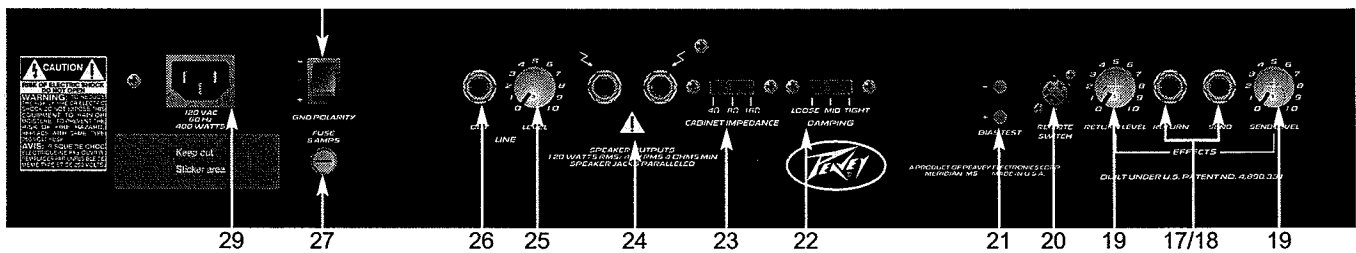

(17/18) EFFECTS SEND / EFFECTS RETURN

These 1/4" mono (TS) jacks allow signal to be sent to and returned from external effects and/or signal processors. Using shielded cables with 1/4" mono (TS) phone plugs, patch from EFFECTS SEND to the input of the external device, and from the output of the external device to EFFECTS RETURN. Only devices that do not increase signal gain should be used in this effects loop (chorus, delay, reverb, etc.). If the footswitch is used, the EFFECTS SELECTOR (33) switch must be depressed to activate the effects loop. See the FOOTSWITCH section of this manual for explanation of switch operation.

(19) EFFECTS SEND/RETURN LEVELS

These calibrated (0 – 10) controls set the level of signal being sent to and returned from external effects and/or signal processors. Clockwise rotation increases the amount of signal counterclockwise rotation decreases the amount. SEND and RETURN levels should be set oppositely, with the SEND level being high and the RETURN level low to ensure the quietest operation.

(20) REMOTE SWITCH

This seven-pin DIN connector is provided for the connection of the remote footswitch. The footswitch cable should be connected before the amp is powered up. See the FOOTSWITCH section of this manual for explanation of switch operation.

(21) BIAS TEST TERMINALS

These terminals are provided to measure the bias of the amplifier's power tubes. A knob behind the back panel grill allows for adjustment. Bias adjustment should only be done by a qualified technician.

(22) **DAMPING SWITCH**

This three-position switch allows adjustment of the amplifier's damping factor. Damping is the ability of an amplifier to control speaker cone motion after a signal disappears. A high damping factor (TIGHT) reduces cone vibration quicker than a low (LOOSE) factor. This switch works much like the resonance and presence controls on other Peavey amps, if those controls were turned simultaneously. If the DAMPING SWITCH is changed, the volume of the amp will also change and require re-adjustment.

(23) **CABINET IMPEDANCE SWITCH**

This three-position switch allows appropriate selection of speaker cabinet impedance. If two enclosures of equal impedance are used, the switch should be set to half the individual value. For example, two 16-Ohm enclosures necessitate an 8-Ohm setting, while two 8-Ohm enclosures would require a 4-Ohm setting. Minimum speaker impedance is 4 Ohms. Normal setting should be switched to 16 Ohms for internal speakers only.

(24) **SPEAKER OUTPUTS**

These paralleled 1/4" mono (TS) jacks are provided for the connection of speaker enclosure(s).



Again, minimum speaker impedance is 4 Ohms. The CABINET IMPEDANCE SWITCH (23) should be set to match the load of the speaker cabinet(s).

(25) **LINE OUT LEVEL**

This control sets the level of signal being sent out of the LINE OUT (26) jack. It may be used to balance the level of slave power amp/speaker systems driven from the LINE OUT (26) to the level of cabinets driven from the SPEAKER OUTPUTS (24).

(26) **LINE OUT**

This 1/4" mono (TS) jack provides a post-power amp signal to drive another power amp/speaker system while maintaining the amplifier's tone.

(27) **FUSE**

A fuse is located within the cap of the fuse holder. This fuse must be replaced with one of the same type and value to avoid damaging the amplifier and voiding the warranty. If the amp repeatedly blows the fuse, it should be taken to a qualified service center for repair.



WARNING: THE FUSE SHOULD ONLY BE REPLACED AFTER THE POWER CORD HAS BEEN DISCONNECTED.

(28) **GROUND POLARITY SWITCH**

This three-position, rocker-type switch should normally be placed in the center (o) position. If hum or noise is noticed coming from the speaker enclosure(s), the switch may be placed in the "+" or "-" position to minimize hum/noise. If changing the polarity does not alleviate the problem, consult your authorized Peavey dealer, the Peavey factory, or a qualified service technician.

(29) **IEC MAINS CONNECTOR**

This is a standard IEC power connector. An AC mains cord having the appropriate AC plug and ratings for the intended operating voltage is included in the carton. The mains cord should be connected to the amplifier before connecting to a suitable AC outlet.



U.S DOMESTIC AC MAINS CORD

The mains cord supplied with the unit is a heavy-duty, 3-conductor type with a conventional 120 VAC plug with ground pin. If the outlet used does not have a ground pin, a suitable grounding adapter should be used, and the third wire should be grounded properly.

FOOTSWITCH

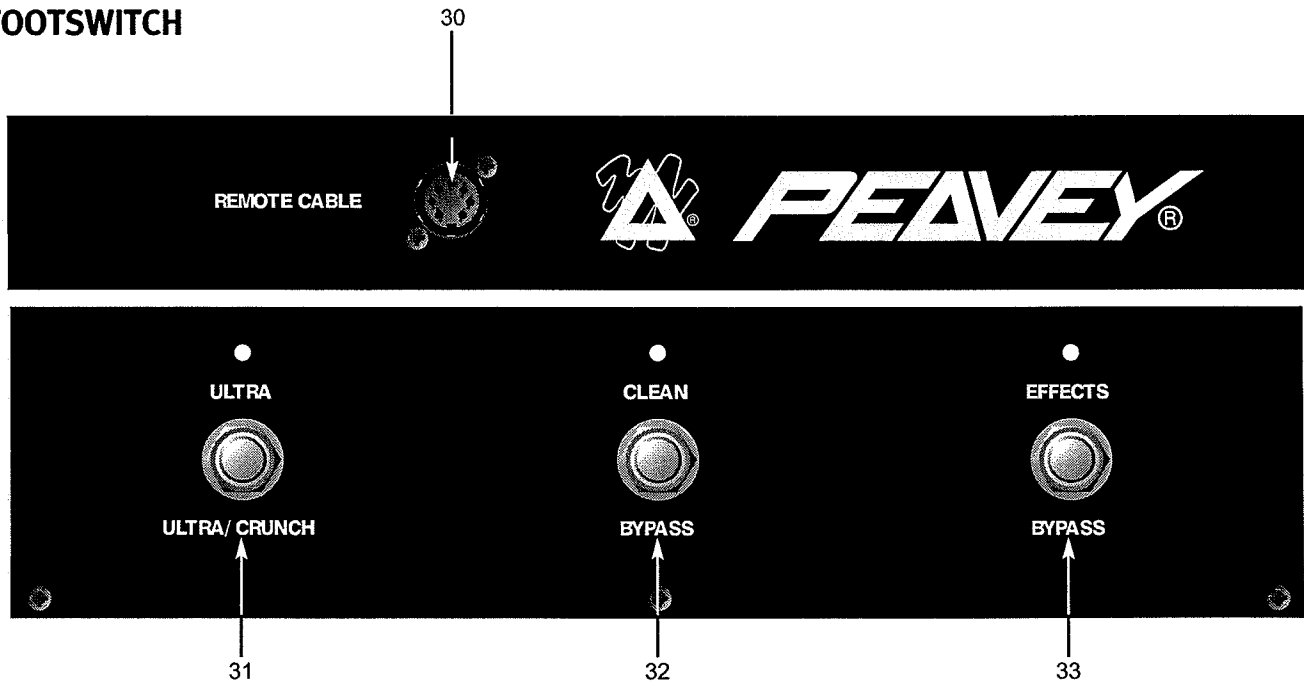

Never break off the ground pin on any equipment. It is provided for your safety.

NOTE: FOR UK ONLY

If the colors of the wires in the mains lead of this unit do not correspond with the colored markings identifying the terminals in your plug, proceed as follows: (1) The wire that is colored green and yellow must be connected to the terminal that is marked by the letter E, the earth symbol, colored green, or colored green and yellow. (2) The wire that is colored blue must be connected to the terminal that is marked with the letter N or the color black. (3) The wire that is colored brown must be connected to the terminal that is marked with the letter L or the color red.

(30) CABLE CONNECTOR

This 7-pin DIN connector is provided for connecting the footswitch to the amplifier REMOTE SWITCH (20) via the cable included in the carton. Connections at the switch and the amplifier should be made before the amp is powered up.

(31) ULTRA / CRUNCH SELECTOR

This switch selects between the Ultra and Crunch channels on the amplifier. The adjacent LED will illuminate when the Ultra channel is selected. When the LED is dark, the Crunch channel is selected. The CLEAN SELECTOR (32) must be in the BYPASS mode to activate either the Ultra or Crunch channel.

(32) CLEAN SELECTOR

This switch selects the Clean channel and will activate regardless of the position of the ULTRA / CRUNCH SELECTOR (31). The adjacent LED will illuminate when the Clean channel is selected. This switch must be in the BYPASS position, indicated by a dark LED, in order to utilize the ULTRA / CRUNCH SELECTOR (31).

(33) EFFECTS SELECTOR

This switch activates the amplifier's effects loop (16 – 19). The adjacent LED will illuminate when the effects loop is active.

TRIPLE XXX SPECIFICATIONS

Triple XXX 212

Power Amplifier Section:

Tubes:

Four 6L6GCs with 12AX7 driver

Rated Power and Load:

120 W RMS into 16, 8, or 4 Ohms

Power @ Clipping:

(typically @ 5% THD, 1 kHz, 120 VAC line)

120 W RMS into 16, 8, or 4 Ohms

Frequency Response:

±3 dB 50 Hz to 20 kHz @ 90 W RMS into 8 Ohms

Hum and Noise:

Greater than 76 dB below rated power

Power Consumption:

Domestic: 400 W, 60 Hz, 120 VAC

Export: 400 W, 50/60 Hz, 220-230/240 VAC

Triple XXX 112

Power Amplifier Section:

Tubes:

Two 6L6GCs with 12AX7 driver

Rated Power and Load:

60 W RMS into 16, 8, or 4 Ohms

Power @ Clipping:

(typically @ 5% THD, 1 kHz, 120 VAC line)

60 W RMS into 16, 8, or 4 Ohms

Frequency Response:

±3 dB 50 Hz to 20 kHz @ 40 W RMS into 8 Ohms

Hum and Noise:

Greater than 76 dB below rated power

Power Consumption:

Domestic: 200 W, 60 Hz, 120 VAC

Export: 200 W, 50/60 Hz, 220-230/240 VAC

The following specs are measured @ 1 kHz with the controls preset as follows:

Low and High EQ @ 10, Mid EQ @ 0

Ultra and Crunch Posts @ 10

Bottom, Body, and Edge EQ @ 5

Effects Send @ 0

Effects Return @ 10

Master Level @ 5

Reverb Level @ 0

Nominal Levels are with Pre Gain @ 5

Minimum Levels are with Pre Gain @ 10

Clean Channel:

Nominal Input Level: -20 dBV, 100 mV RMS

Minimum Input Level: -30 dBV, 30 mV RMS

Maximum Input Level: 0 dBV, 1.0 mV RMS

Crunch Channel:

Nominal Input Level: -80 dBV, 0.1 mV RMS

Minimum Input Level: -90 dBV, 0.03 mV RMS

Ultra Channel:

Nominal Input Level: -80 dBV, 0.1 mV RMS

Minimum Input Level: -90 dBV, 0.03 mV RMS

Effects Send:

Load Impedance: 47 k Ohms or greater

Minimum Output: -10 dBV, 300 mV RMS

Maximum Output: 0 dBV, 1 V RMS

Effects Return:

Impedance: High-Z, 80 k Ohms

Minimum Input Sensitivity: -10 dBV, 300 mV RMS

Maximum Input Sensitivity: 0 dBV, 1 V RMS

Line Output:

Load Impedance: 47 k Ohms or greater

Adjustable Output: ±20 dBV, 0.1 V RMS-10 V RMS

Remote Footswitch:

Special 3-button unit with LED indicators (supplied)

System Hum and Noise @ Nominal Level:

(Clean channel, 20 Hz to 20 kHz unweighted)

Greater than 74 dB below rated power

(Special noise gate circuitry for Ultra & Crunch)

Equalization (Clean channel only):

Custom Low, Mid, and High passive type EQ

Voicing (Ultra and Crunch channels only):

Active Bottom, Body, and Hair (Edge) EQ

Boost/Cut ±12 dB

Dimensions and Weight:

Triple XXX 212:

20.5" (521 mm) H x 26.5" (673 mm) W x 11.25" (286 mm) D

83.5 lbs. (37.9 kg)

Triple XXX 112:

19" (483 mm) H x 23" (584 mm) W x 11" (279 mm) D

60 lbs. (27.2 kg)

Triple XXX 112/212 Combo Block Diagram

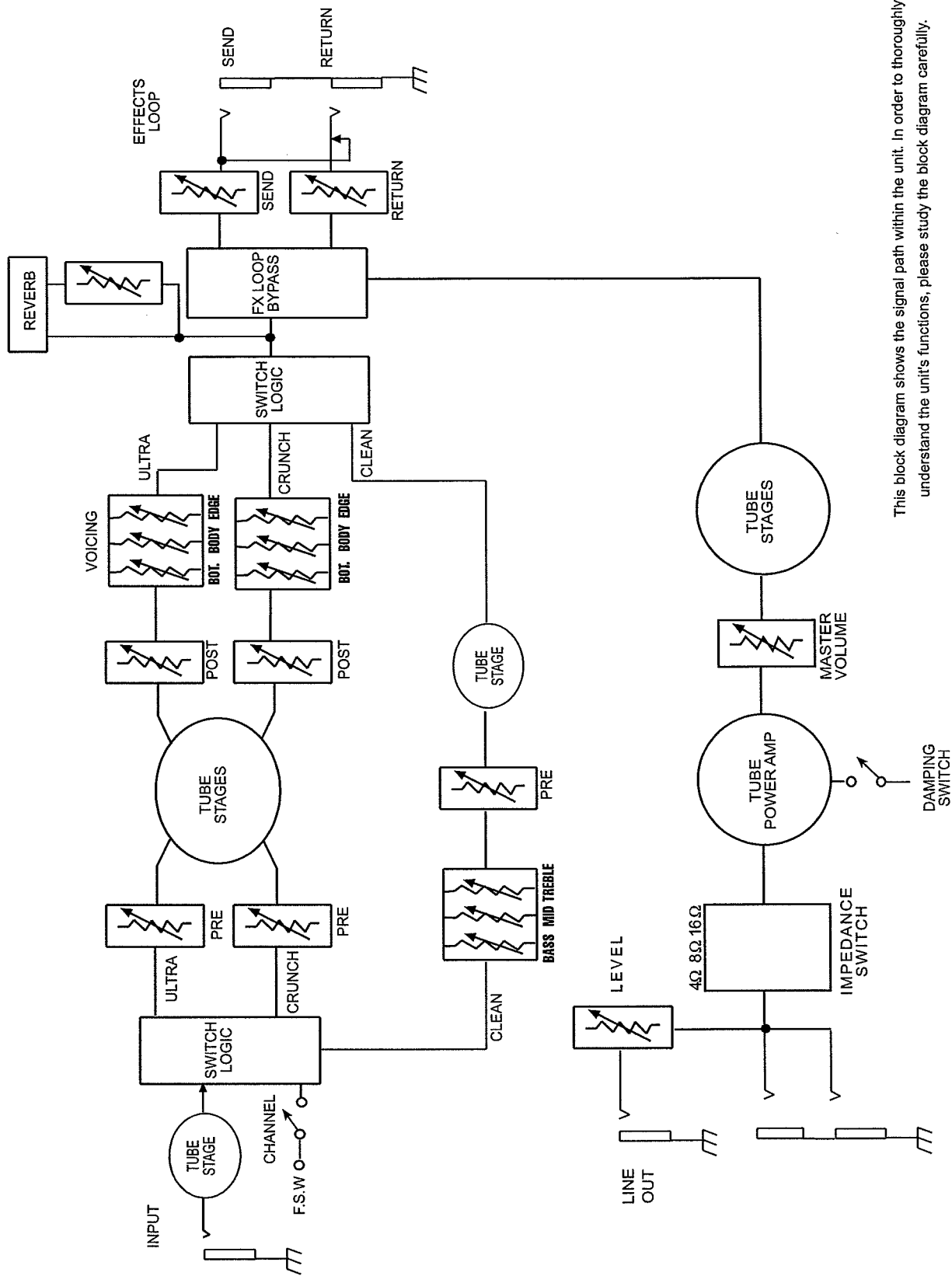

This block diagram shows the signal path within the unit. In order to thoroughly understand the unit's functions, please study the block diagram carefully.